

# 騒音データ Noise data

騒音値 Noise Level

測定環境 Environment	無響音室 Anechoic room
測定位置 Location	距離1.5m 高さ1.0m Distance1.5m Height1.0m
測定特性 Characteristic	A特性 A-Characterstic

dB(A)

形 式 Model	前 Front	後 Back	左 Left	右 Right
CLP75EF-14	56	65	60	60
CLP75EF-14D	56	65	60	60

注意. この騒音データは平均値です。

Notice. These noise data are average value.

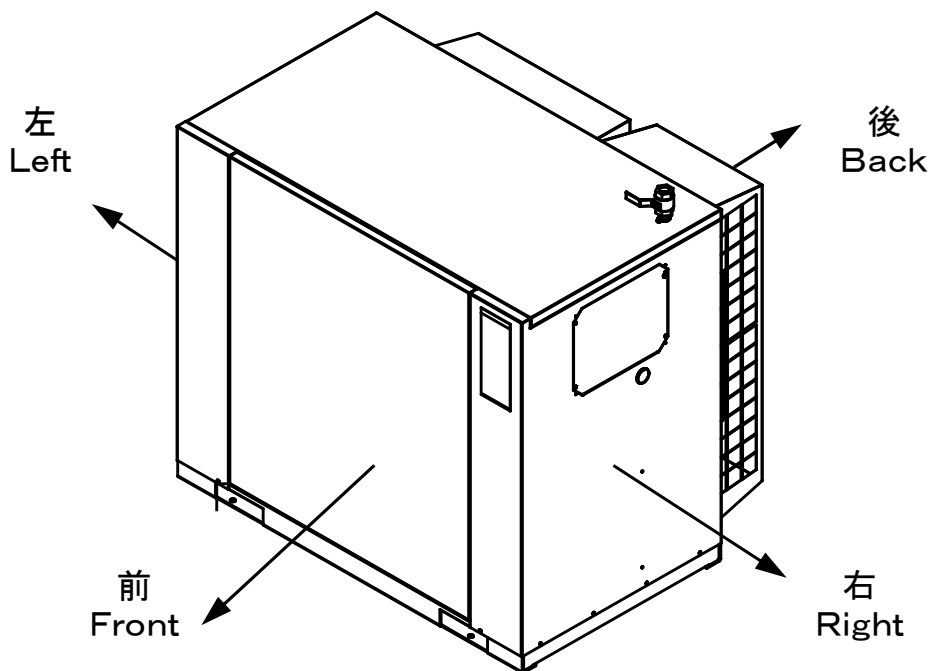

**ANEST IWATA Corporation**